

**DRAWINGS SHOWN ARE REFERENCE ONLY**

**Very High Performance, Single/Dual/Tri Durometer, Co-extruded Weather seals**

**Micro-cellular Foam**

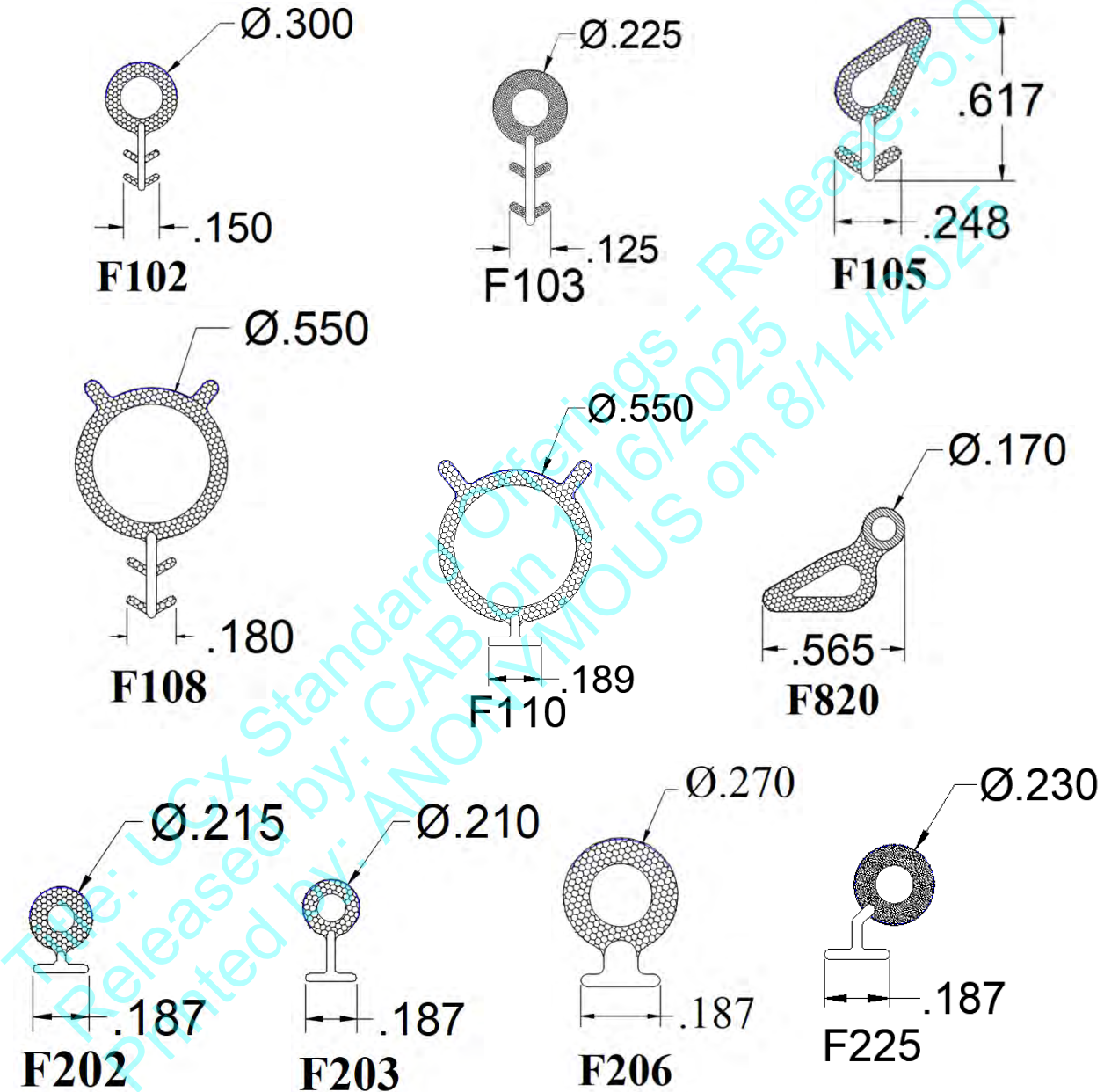

**DRAWINGS SHOWN ARE REFERENCE ONLY**  
**Micro-cellular Foam**

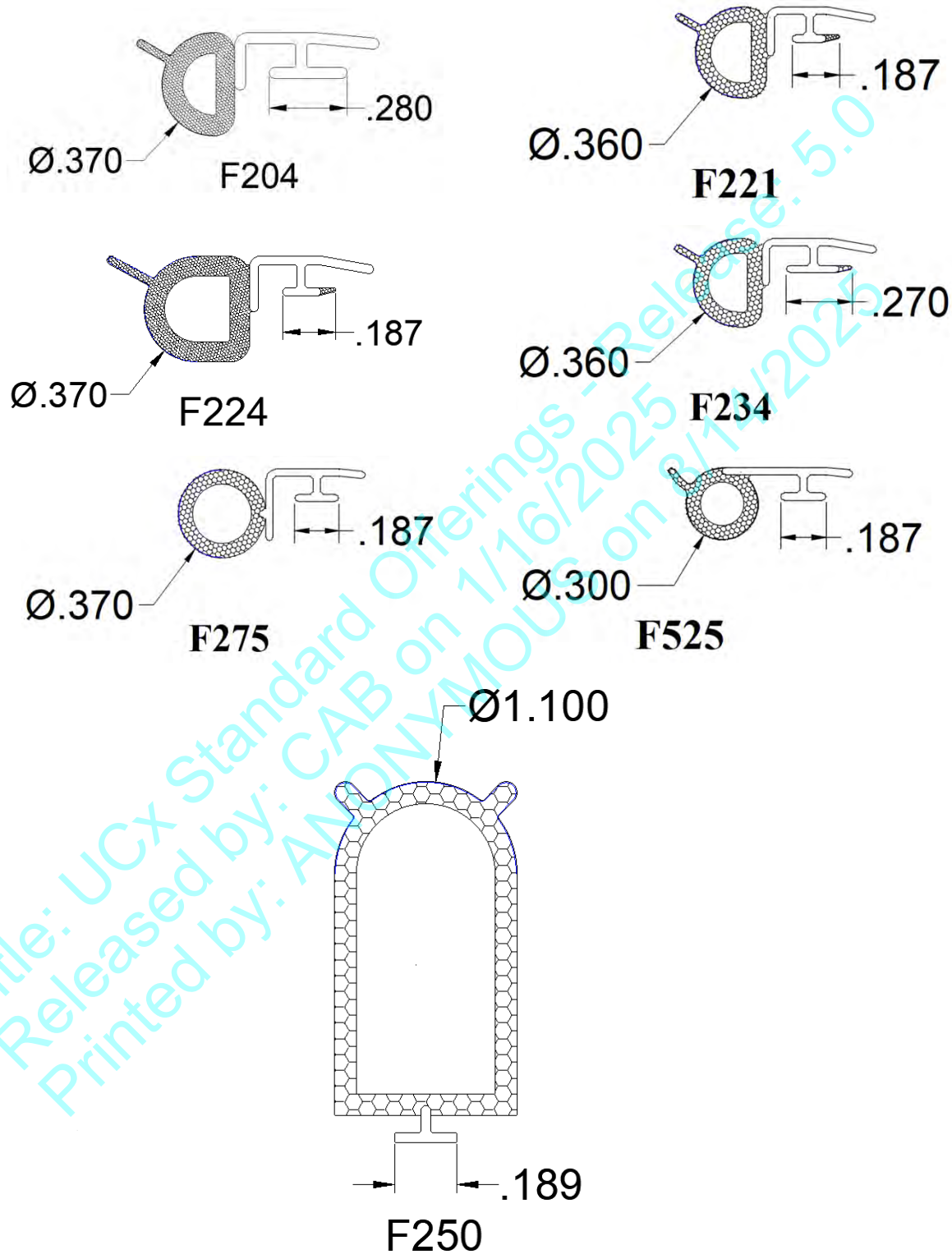

**DRAWINGS SHOWN ARE REFERENCE ONLY**  
**Multi-Hollow Bulb Seals**

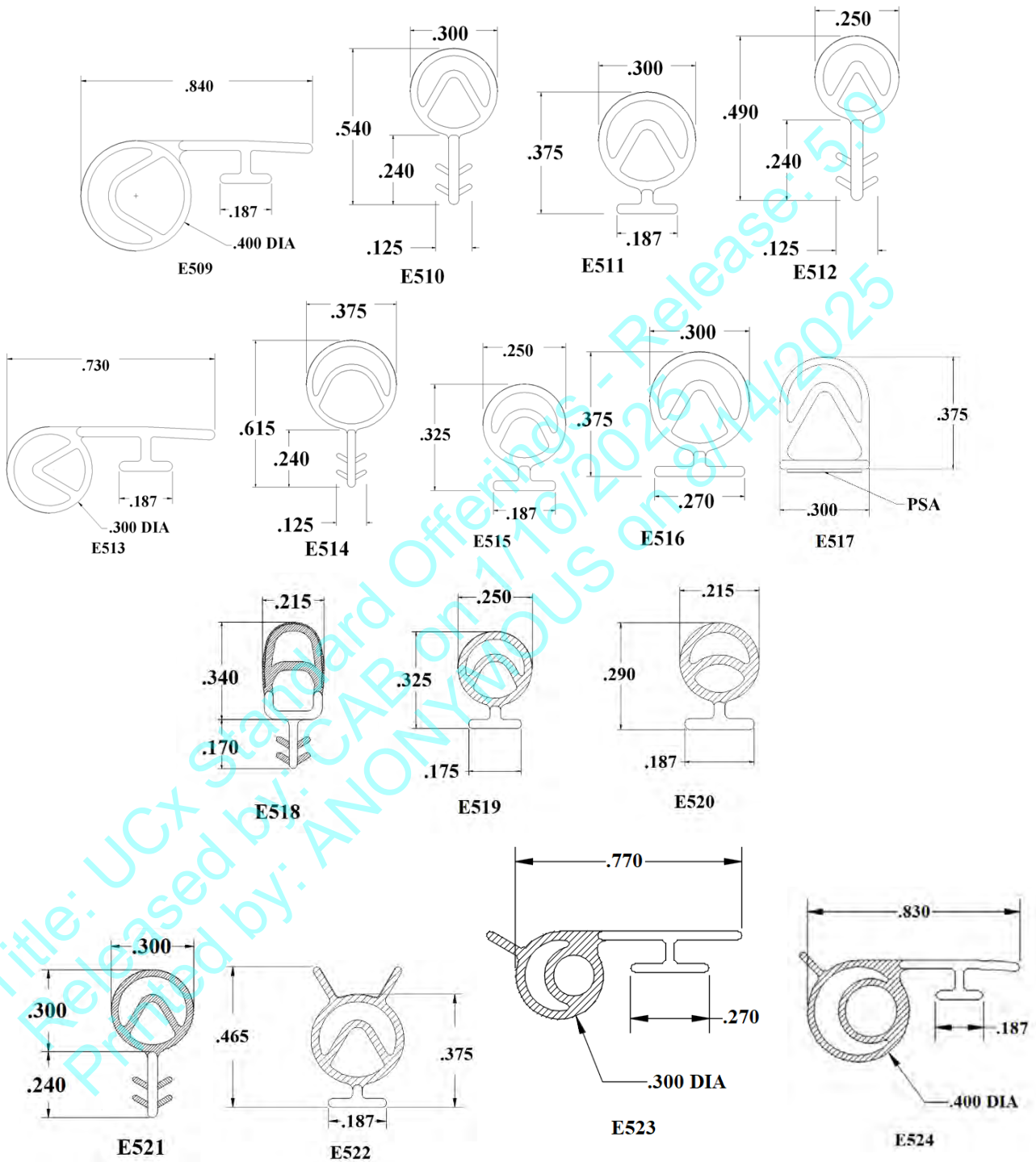

**DRAWINGS SHOWN ARE REFERENCE ONLY**  
**Multi-Hollow Bulb Seals**

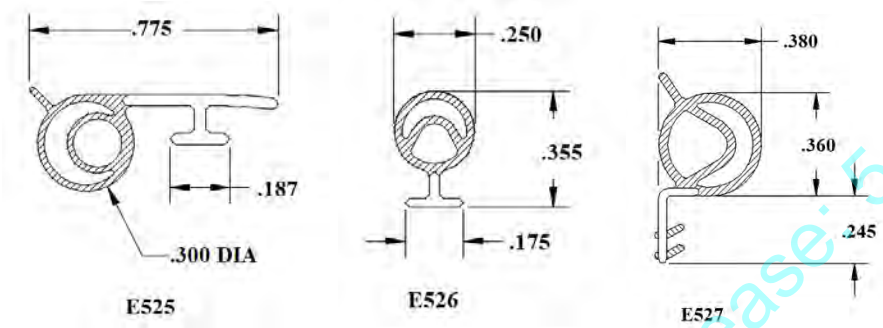

**Polypropylene Leaf Seals**

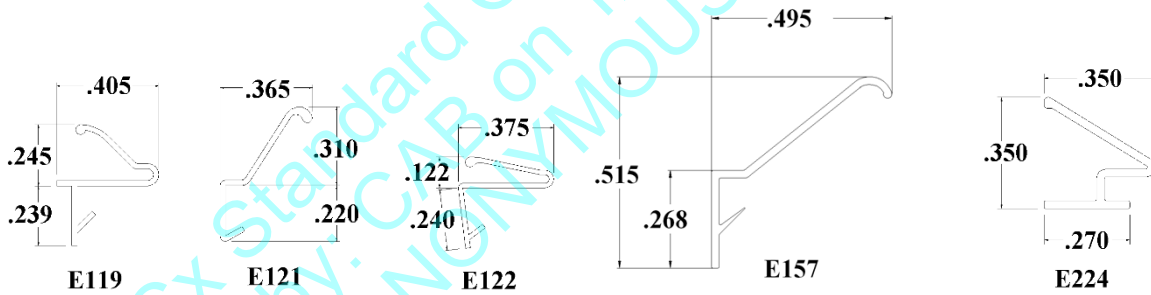

**DRAWINGS SHOWN ARE REFERENCE ONLY**  
**Push-In Seals**

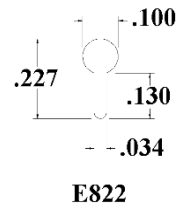
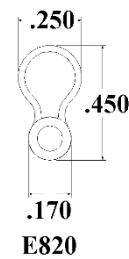
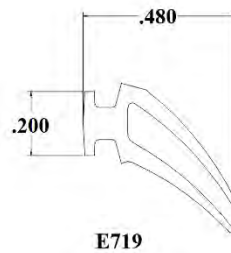
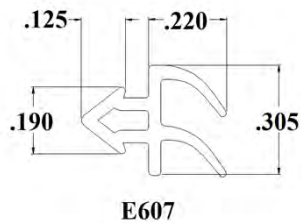
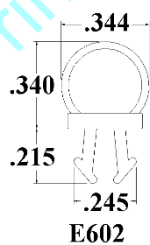
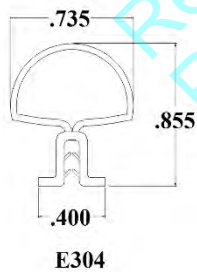
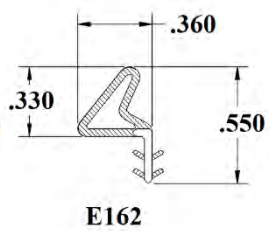
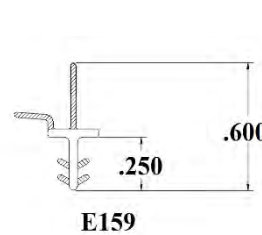
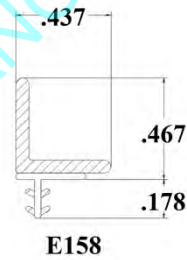
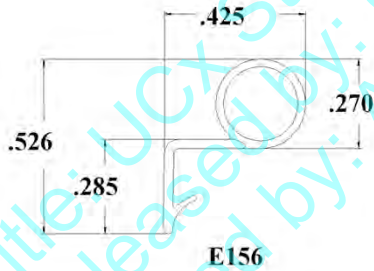
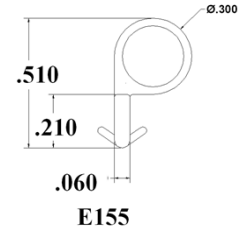
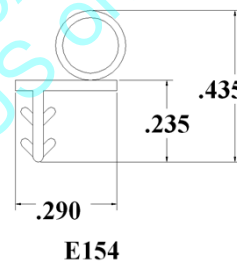
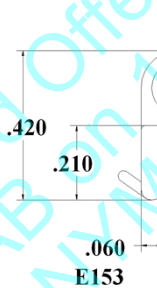
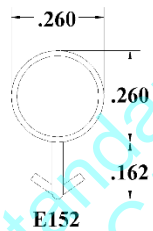
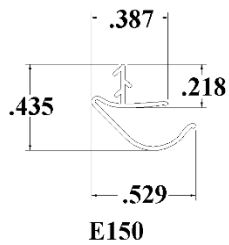
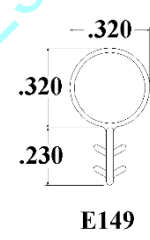
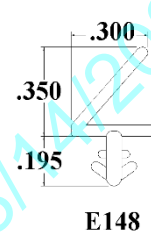
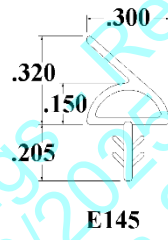
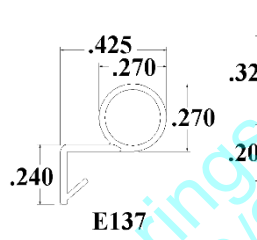
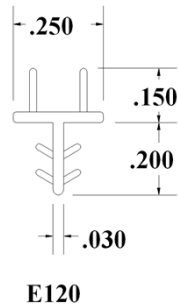
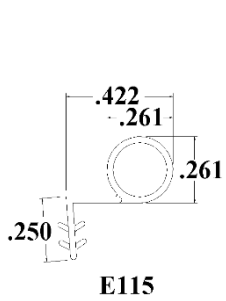
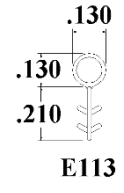
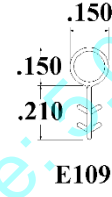
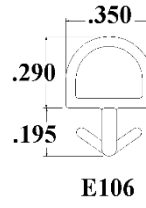
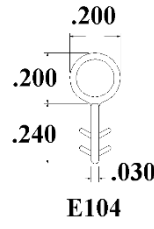
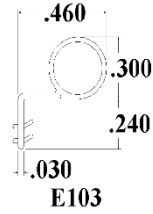
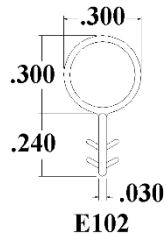
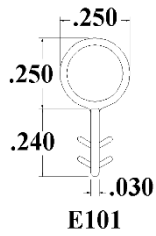

**DRAWINGS SHOWN ARE REFERENCE ONLY**  
**T-Slot Options**

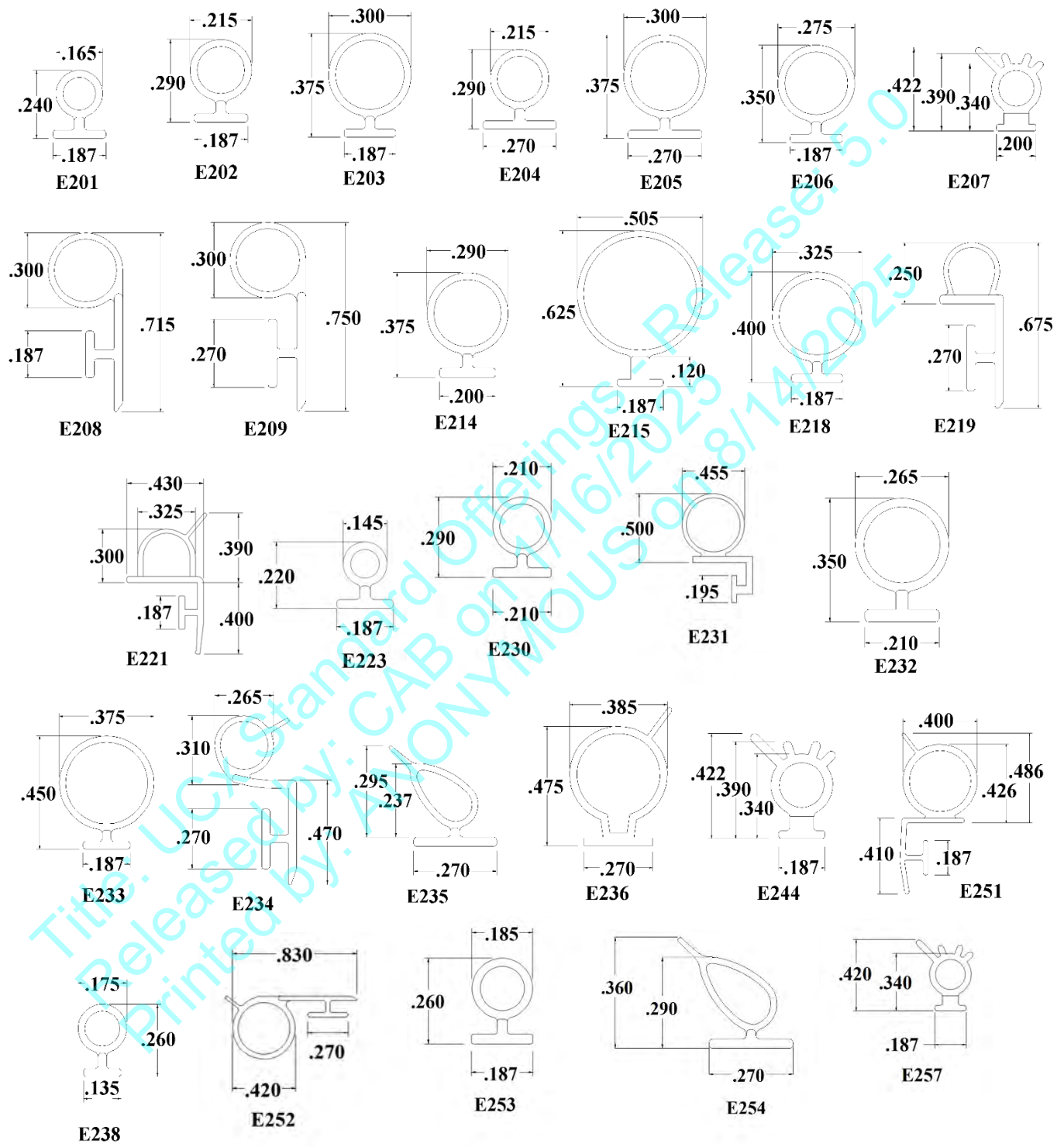

**DRAWINGS SHOWN ARE REFERENCE ONLY**  
**T-Slot Options**

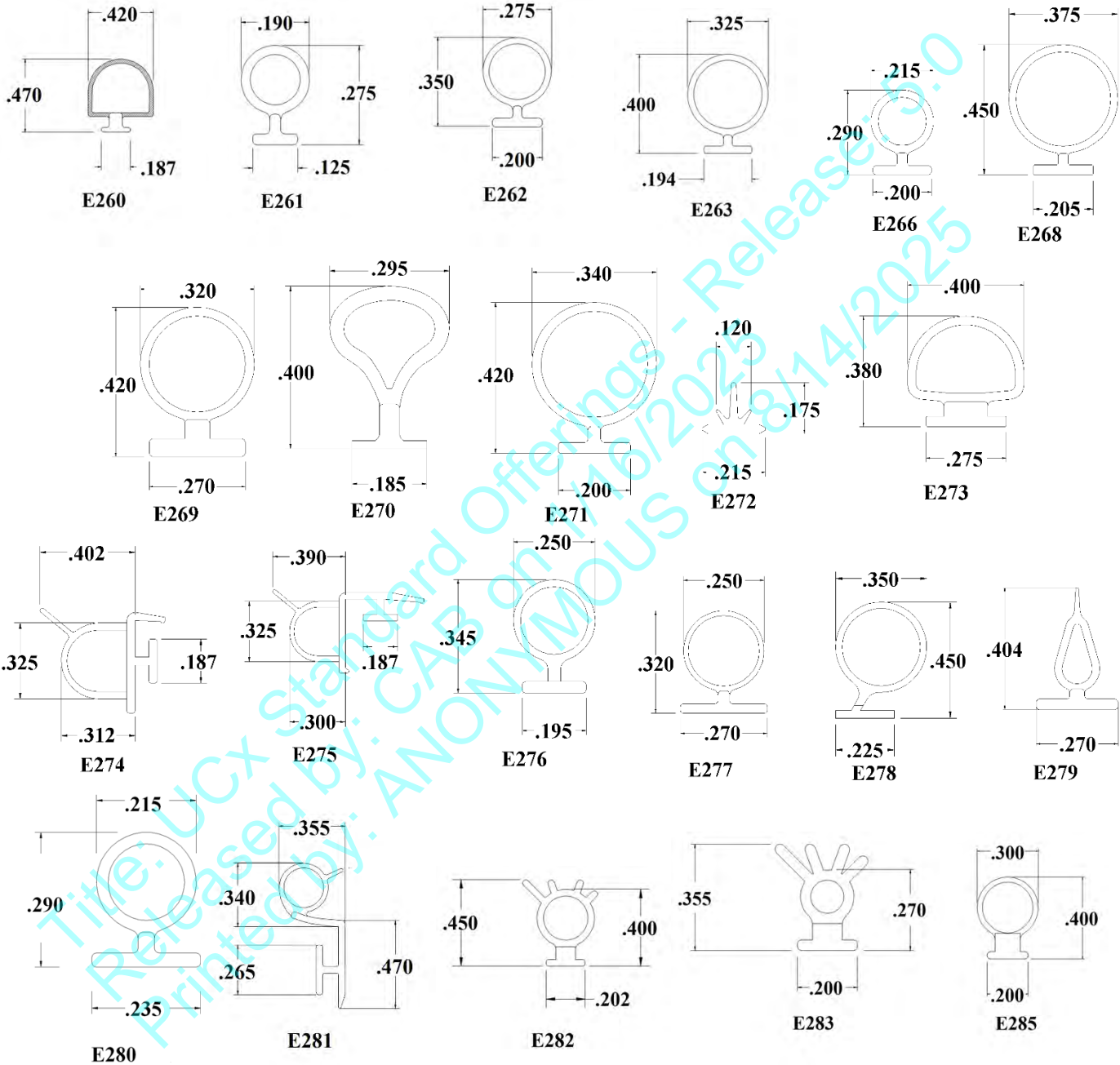

**DRAWINGS SHOWN ARE REFERENCE ONLY**  
**T-Slot Options**

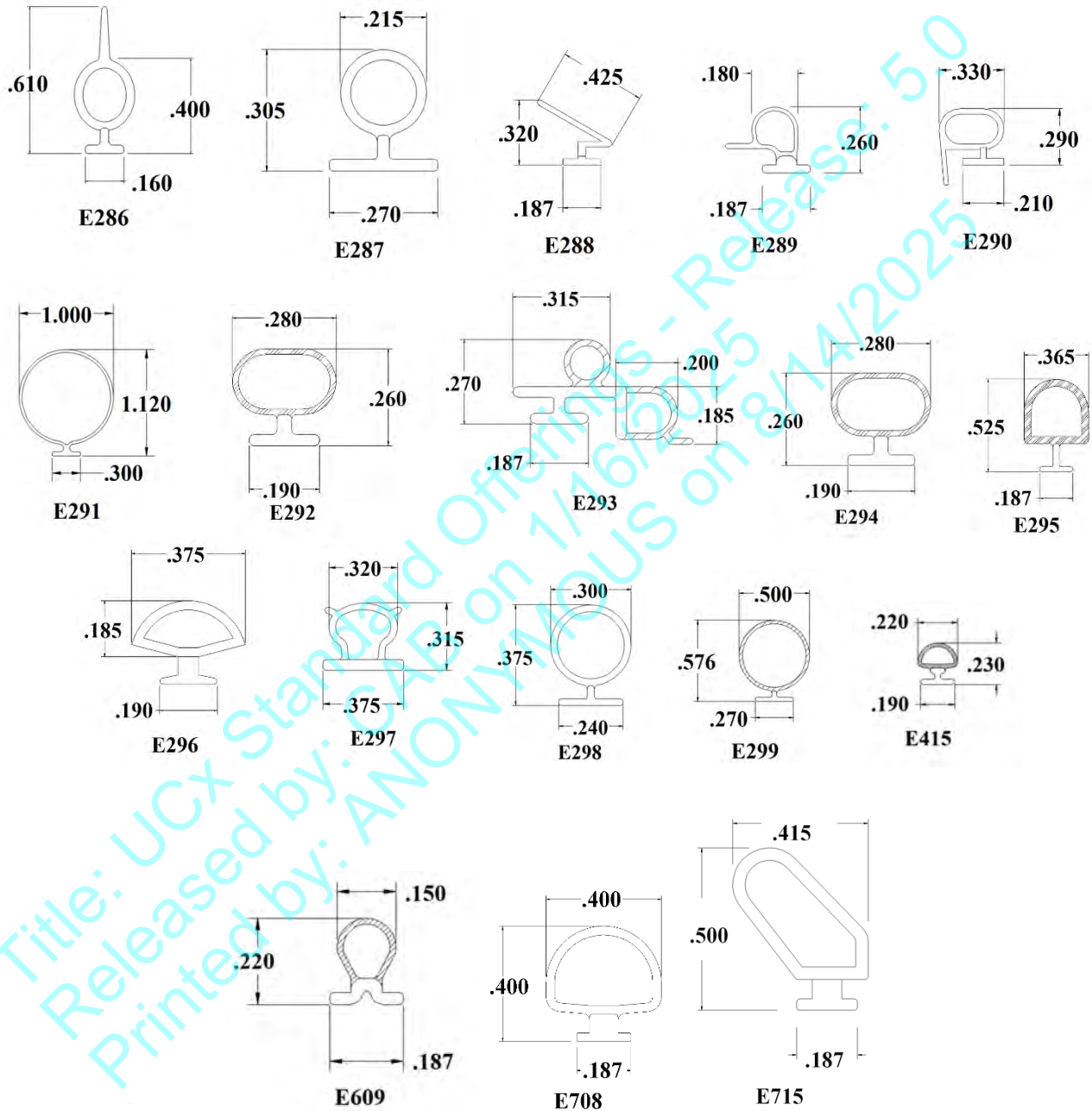

**DRAWINGS SHOWN ARE REFERENCE ONLY**

**DRAWINGS SHOWN ARE REFERENCE ONLY**  
**Kerf/Clip/Specialty Mounted Pile**

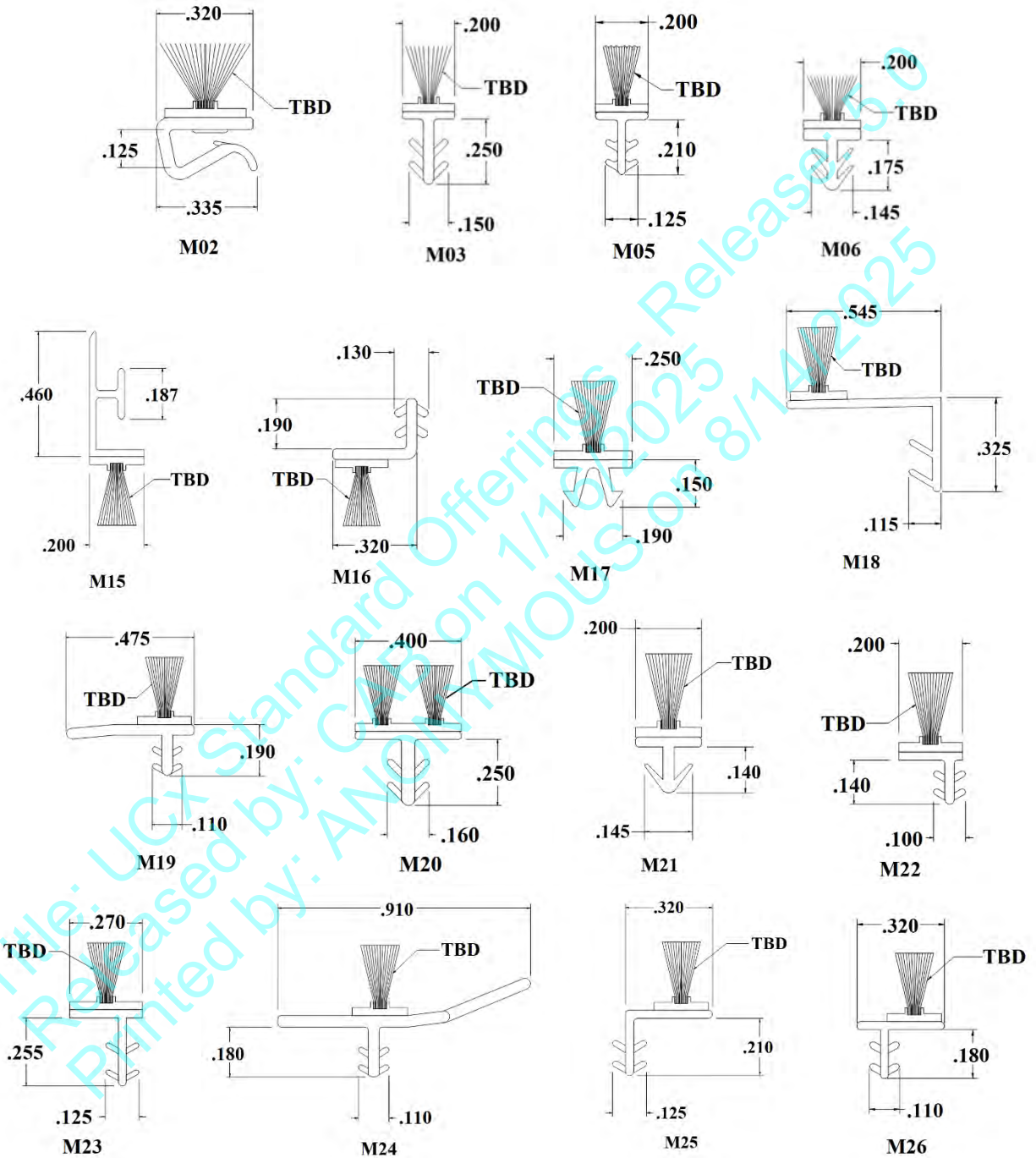

**DRAWINGS SHOWN ARE REFERENCE ONLY**  
**Kerf/Clip/Specialty Mounted Pile**

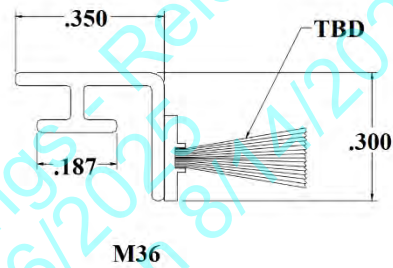
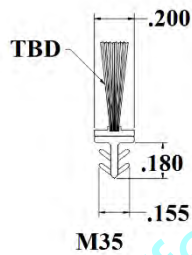
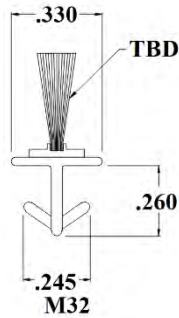
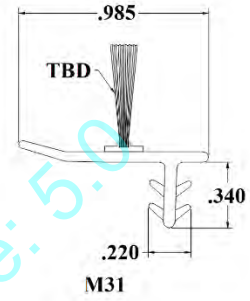
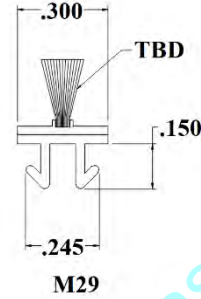
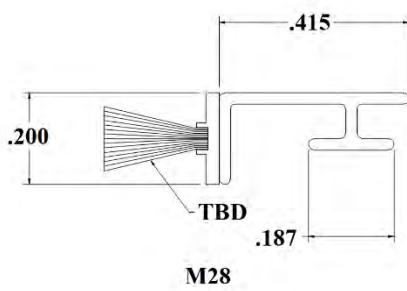
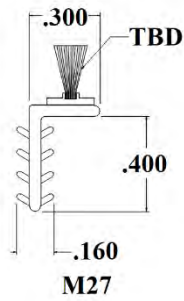

Title: UCx Standard Offerings  
 Released by: CAB on 1/16/2025  
 Printed by: ANONYMOUS on 8/14/2025

## Appendix A - Kerf Base Brush Width Table

### KERF BASE BRUSH WIDTH TABLE

PROFILE BASE	BRUSH BASE WIDTH
M02	.270"
M03	.200"
M06	.200"
M15	.200"
M16	.200"
M17	.250"
M18	.200"
M19	.200"
M20	.400"
M21	.200"
M22	.200"
M23	.270"
M24	.200"
M25	.200"
M26	.200"
M27	.200"
M28	.200"
M29	.270"
M31	.200"
M32	.200"
M35	.200"
M36	.200"
M37	.200"
M38	.200"

Title: UCx Standard Offerings  
 Released by: CAB on 1/16/2025  
 Printed by: ANONYMOUS on 8/14/2025  
 Release: 5.0